

Godrej



***Intelligent Energy Saving
Compressed Air Flow Control System***



Compressed Air - Boon or Bane

Compressed air is the most widely used form of energy across manufacturing industry accounting 10% of the worldwide electricity consumption! It is safe to handle, easy to transmit for speed & torque applications.

Compressed air powers a variety of equipment such as pneumatic cylinders in machine tools & process automation, air bearings, instrumentation gauges, spray painting, conveying, diaphragm pumps, portable tools such as screw drivers, grinders, hammers, rock drills, nailing & nut runners, movement of doors & hoists as well as vacuum pick-ups.

Applications of compressed air are found in Automobile assembly lines, PET Bottling, Cement, Glass, Steel, Ferrous & Non-ferrous manufacturing, Forging, Power plants, Mining, Textile Air Jet looms, Spinning, Weaving, Electronics and what not!

Due to such a vast requirement, compressed air is often referred as industry's fourth utility.

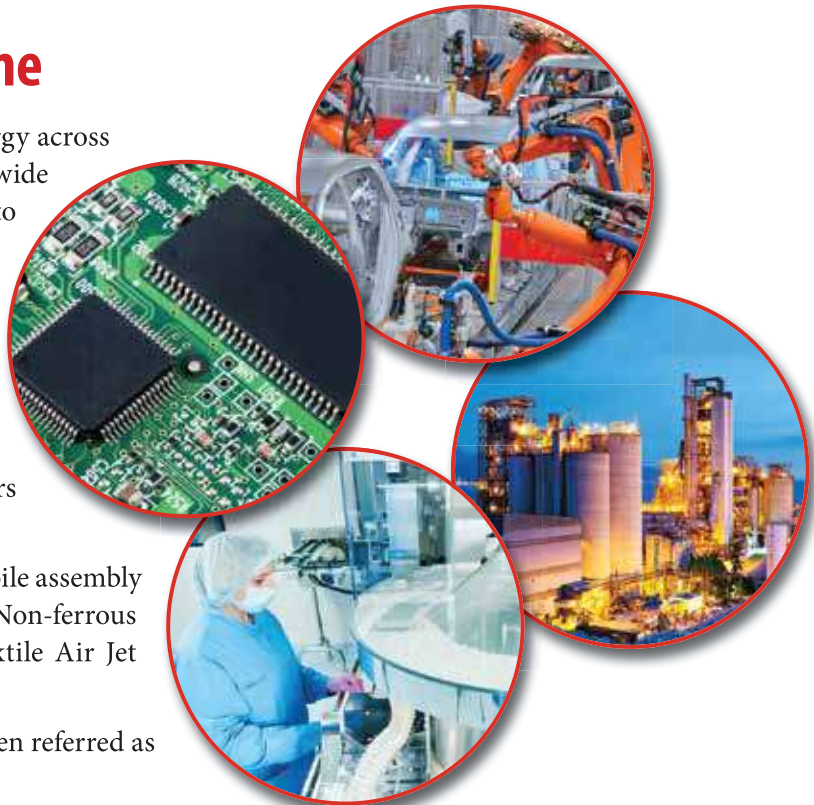

However there are two major issues with generation & supply of compressed air.

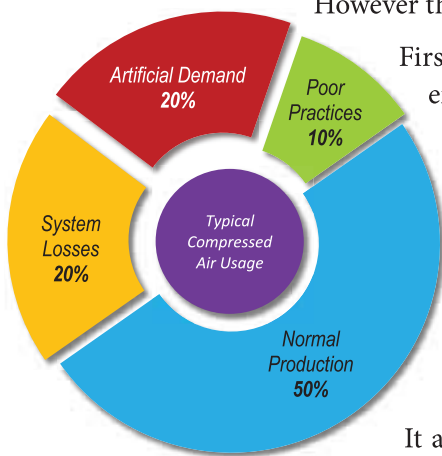

Firstly, it takes 7 units of electrical energy to produce 1 unit of equivalent pneumatic energy. Further, a typical compressed air system wastes 50% of the air produced! This results in high energy consumption.

Secondly, fluctuating air pressure caused by intermittent use of multiple pneumatic equipment affects their performance.

A sudden air demand causes pressure drop at the point of use. Air Compressors detect it only when it travels upstream through the distribution network. The response is to Load a Compressor or increase in speed by VSD to meet the demand.

It actually takes a while for the entire air system to attain the desired pressure. To overcome this lag in response time between Demand & Supply, compressed air system is maintained at higher level of pressure to meet the sudden demand, leading to wastage of compressed air and an inefficient energy system translating into inflated energy bills.

Issues with Fluctuating Air Pressure

- ▶ Higher Energy Consumption
- ▶ Inconsistent equipment performance
- ▶ Increased maintenance costs
- ▶ Premature equipment failure
- ▶ Higher operating costs
- ▶ Interruptions in production schedules

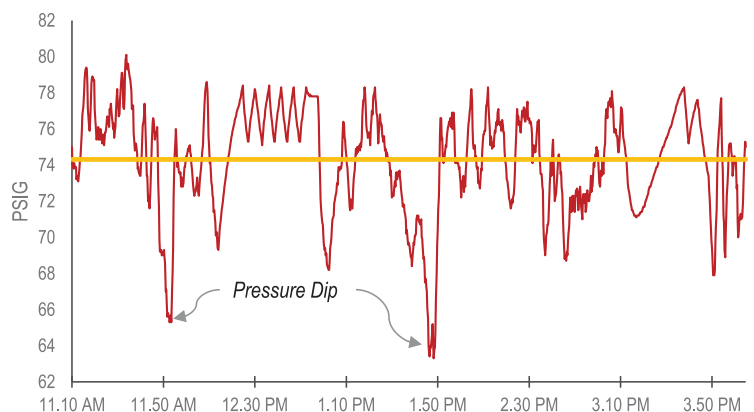

Rein in your Compressed Air Energy... ...with Godrej ControlAIR™ IFC system

ControlAIR™ Intelligent Flow Control System (IFC) reduces artificial demand by controlling the air flow & pressure being delivered to the plant. The IFC is designed specifically to operate at an intermediate point of the compressed air system i.e. on the downstream side of the air treatment equipment and upstream side of the main piping distribution system.

ControlAIR™ IFC creates useful storage by introducing a controlled differential pressure across an upstream receiver and itself. This storage isolates the Compressors from demand side fluctuations.

Peaks are dealt with releasing the stored reserve energy instead of additional horsepower, facilitating the Compressors to run on reduced load. ControlAIR™ IFC provides air at a controlled differential and optimum pressure to the plant, which reduces the mass of air consumed by pneumatic equipment, tools & amount of leakages, which ultimately result in the reduction in energy consumed by Air Compressors.

Industry 4.0 ready



Benefits

- Saves Compressed Air Energy by 4~25 % through reduction in Artificial Demand
- Improves pneumatic equipment performance with constant air pressure within the range of +/- 1 psig (0.07 barg)
- Improves the response time of system to meet instantaneous demand
- Reduction in compressor's operation and maintenance
- Reduction in compressed air leakages
- Works with all brands and types of compressors
- Payback period between 1~2 years
- Improves VSD Performance

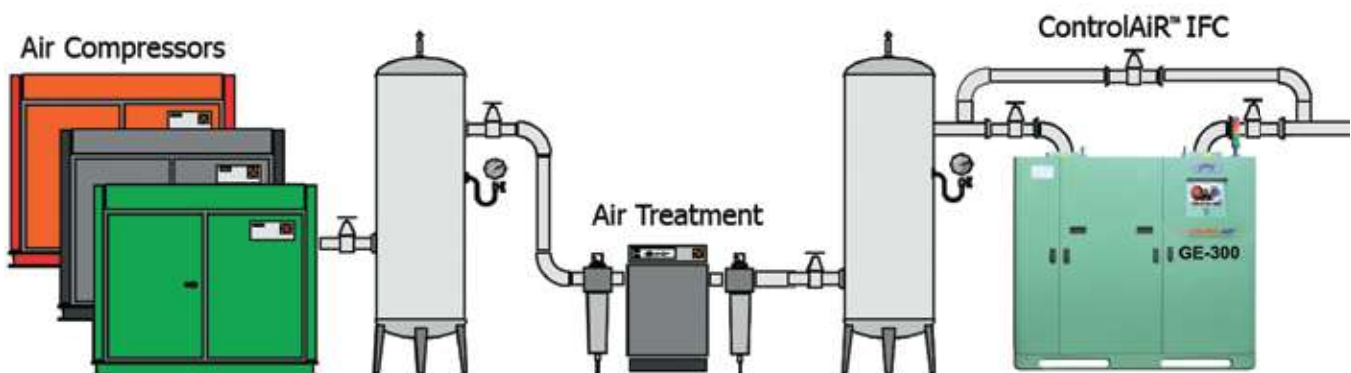
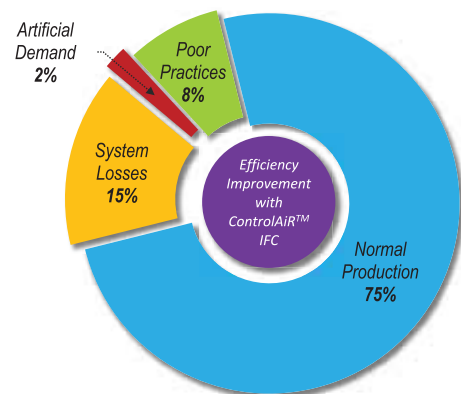

Typical Installation of IFC in a Compressed Air System

HMI Touch Screen Display

ControlAiR™ IFC is user friendly with HMI Touchscreen Colour Graphics Display showing multiple screens to exhibit following information.

- Dashboard screen displays the Inlet pressure, Set Pressure, Actual Discharge Pressure, percentage opening of flow control modules, current status and error logs.
- Online Pressure Trend of Inlet and Outlet pressure.
- Run hours, Service due hours.
- Historical data of pressure values, errors w.r.t. date & time which can also be retrieved via the USB port.

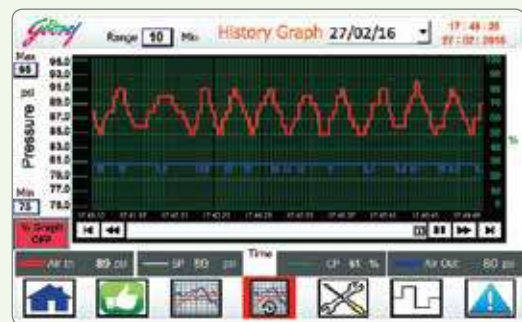

Features

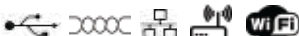
- Precise control through 32-bit Intelligent Microprocessor Controller
- Detects the rate of change of demand to increase/decrease the flow/pressure.
- Fail-safe operation with fail-to-open flow control modules & additional auto bypass
- Less than 1 psig / 0.07 barg pressure drop across IFC system at nominal flow
- Built-in filters & air dryer with automatic condensate drain for instrument quality pilot air
- Inlet & Outlet headers provided with No-Air Loss automatic condensate drains
- Power failure Auto-restart facility
- Analogue input for compressed air flow meter & built-in flow totalizer software as standard
- Customized Upstream & Downstream Flow Control Systems as per system requirements
- Available for higher working pressures of 13 / 16 / 40 bar(g)
- Aesthetically designed ergonomic enclosure
- ControlAiR™ IFC is a patented product of Godrej
- Industry 4.0 Ready 

Operational Features

- Remote Operation (Start/ Stop, Target Pressure setting)
- 3 Preset Target Pressures can be remotely selected
- Weekly Programmable 28 Pressure settings scheduler
- Special program to work with Centrifugal compressors to avoid surge
- Optional PC connectivity

Technical Specifications

Model	Nominal Flow Capacity	Connection Flange Ø	Dimension (L x W x H) in mm			Distance between Inlet & Outlet	Weight
	SCFM (SM ³ /hr)		Length (A)	Width (B)	Height (C)		
GE-10	500 (850)	80	1000	750	1050	651	230
GE-20	1000 (1700)	80	1000	750	1050	651	240
GE-30	1500 (2550)	100	1000	750	1050	651	300
GE-45	2250 (3800)	150	1000	750	1050	651	350
GE-60	3000 (5100)	150	1430	850	1350	950	580
GE-75	3750 (6370)	150	1430	850	1350	950	590
GE-90	4500 (7650)	200	1430	850	1350	950	650
GE-120	6000 (10,200)	200	1430	850	1350	950	700
GE-150	7500 (12,740)	200	1430	850	1350	950	750
GE-200	10,000 (17,000)	250	1700	1000	1600	1100	850
GE-250	12,500 (21,250)	250	1700	1000	1600	1100	950
GE-300	15,000 (25,500)	300	1700	1000	1600	1100	1050
UPC-10	500 (850)	80	1000	750	1050	651	200
UPC-20	1000 (1700)	80	1000	750	1050	651	240
UPC-30	1500 (2550)	100	1000	750	1050	651	300
UPC-45	2250 (3800)	150	1000	750	1050	651	350
UPC-60	3000 (5100)	150	1430	850	1350	950	580

CE Certified for European Market

Power Supply : 230 Volts, 50 Hz, Air Pressure : 150 psig (10 barg)

Options

- Power Supply: 110 Volts, Frequency: 60 Hz
- Air Pressure: Up to 40 bar (Dimension & weight may differ than above table)
- Manifold Material: Aluminum or Stainless Steel

Dimensions

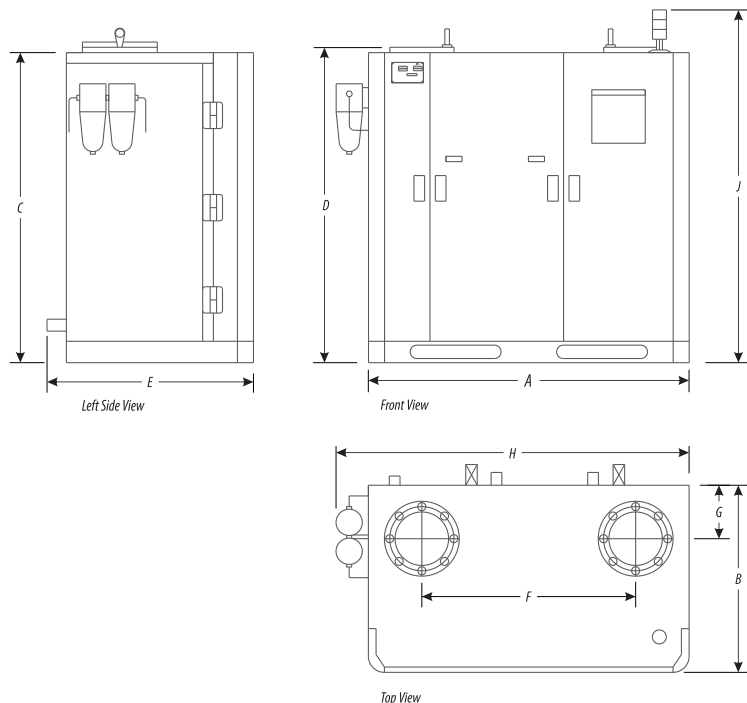

With our continuous improvement program, we reserve the right to alter specifications & prices without prior notice.

You Can't Manage What You Don't Measure

Our expert engineering team / Channel Partners conduct compressed air system audit of your plant. We analyze the data collected to estimate energy saving potential with a right solution. After you install ControlAiR™ IFC Systems as per our recommendation, we demonstrate the performance in terms of stable air pressure & energy savings in Air Compressors.

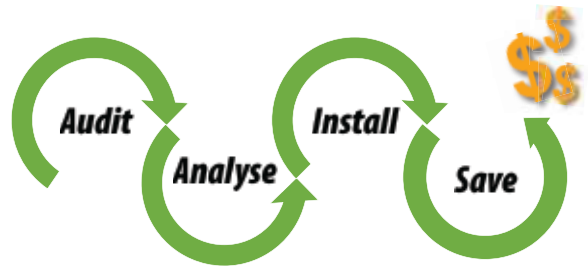

Typical Case Studies

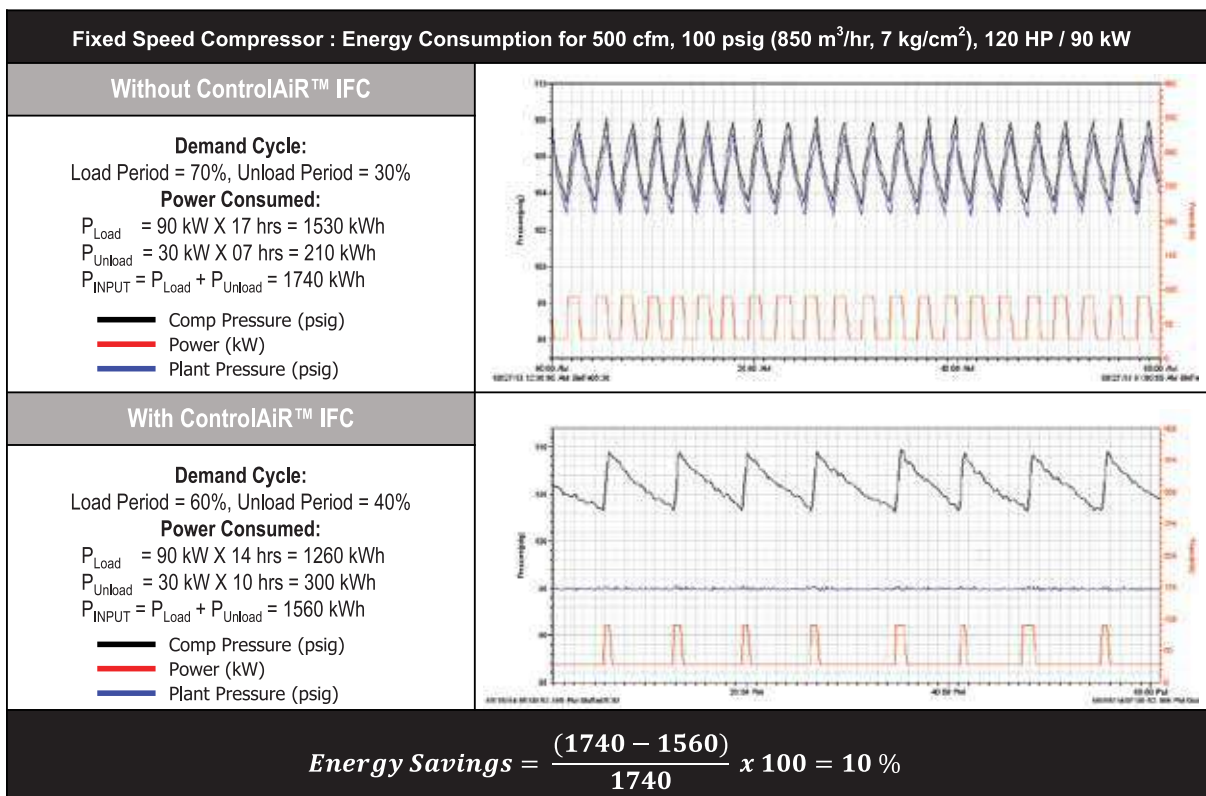
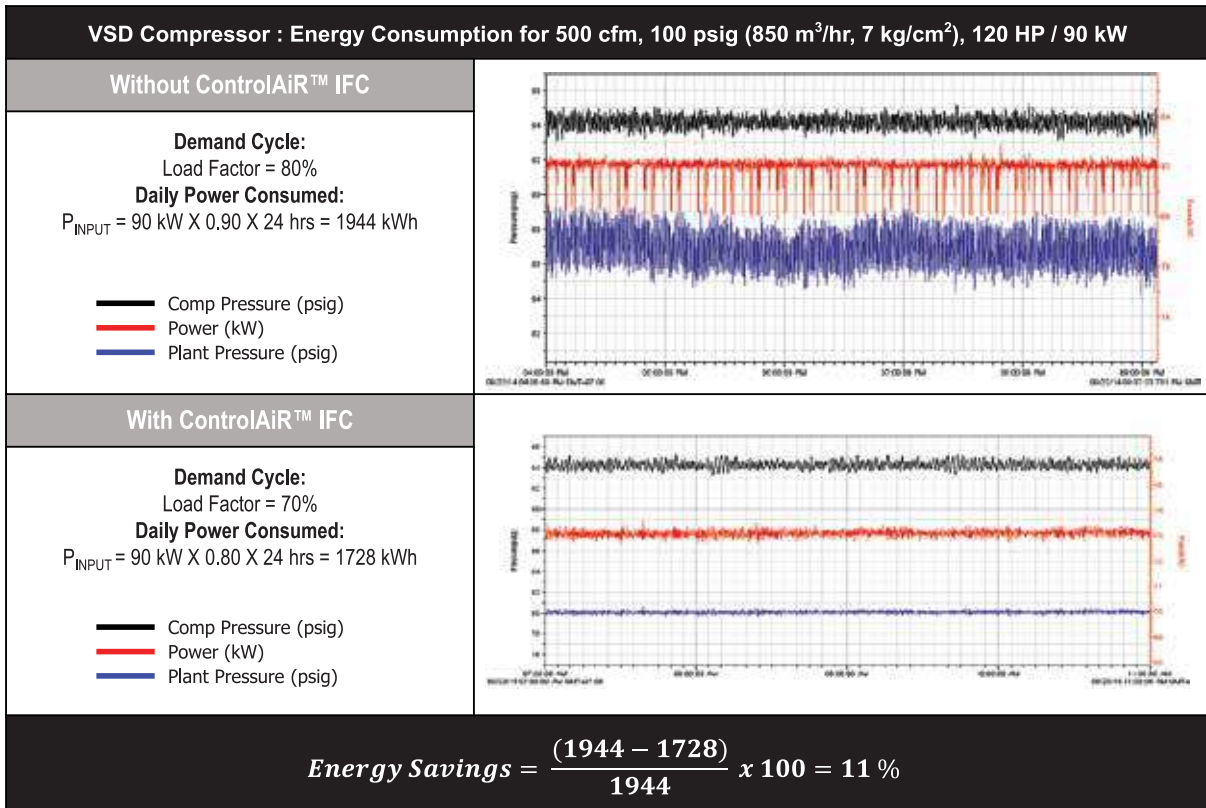



The Amazing World of Godrej

More than 120 years ago, a young man, Ardeshir Godrej gave up law and turned to lock making. The word Godrej etched into the metal of his locks stood for trust, security and reliability. The name Godrej is today in the mind of every Indian as a symbol of responsible entrepreneurship, self-reliance through industry and prosperity from indigenous resources. Godrej is the bridge between the future and a hundred years of history, it is a living code of ethics for Indian industry as it races into the forefront of business excellence.

Welcome to the amazing world of Godrej, where technology goes hand in hand with people. Where innovation is spoken in the same breath as existence. Where tomorrow is moulded today. Where, more than 28000 people work towards a common goal of excellence, through sprawling industrial garden township in India & Abroad. Through fields as diverse as Industrial Products, Office Equipment, Household Appliances, Security Equipment, Consumer Products and Chemical Agro Products, a group sales turnover of over \$4 billion USD. Thousands of path-breaking products and services sport one name that an entire country relies on for absolute quality - Godrej.

And just as it was called a 120 years ago, even today it is quite simply called Godrej, a company with Global vision and Indian roots.

The Godrej Group touches the lives of 500 million Indians who use at least one of our products every single day. Our commitment to quality, attention to detail and customer centricity has helped us earn the trust of generations of Indians.



Drawing from its rich and varied heritage and its quest for growth, Godrej Electricals and Electronics business one of the many business areas of the Godrej group, is as old as the company. The brand strives to contribute to the vision of the group by delivering sustainable technology solutions with its Product and Service offerings and intends to foray beyond its national borders. Keeping pace with Innovation and Technology it has already made inroads into emerging markets around the world.

Godrej Electricals & Electronics is a one-stop shop for sustainable technology solutions. With over 100 years of experience and a countrywide network, the brand offers solutions compliant with the highest industry standards, to clients across a plethora of industries and geographies.



"We do not inherit the Earth from our Ancestors,
we borrow it from our Children"



Global Presence

• INDIA • CHINA • TAIWAN • THAILAND • MALAYSIA • INDONESIA • SINGAPORE • NETHERLANDS • SOUTH KOREA

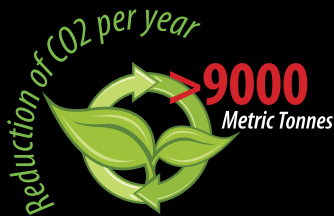

Registered Office

GODREJ & BOYCE MFG. CO. LTD

Godrej Electricals & Electronics, Compressed Air Solutions,
Pirojshanagar, Vikhroli, Mumbai 400079
Tel: +91-22-6796 2251/2259, Fax: +91-22-6796 1410/1525
Email: casene@godrej.com
Website: www.godrej-air solutions.com

Branch Offices in India

NEW DELHI

Godrej Bhawan, Sher Sun Marg, Okhla, New Delhi 110065.
Tel: 011-666507192 (D), Fax: 011-6650 7056

CHANDIGARH

Plot No. A-40, Phase-VII-A, Industrial Area, Mohali 160059.
Tel: 0172-5037 777/788

JAIPUR

502-506, 5th Floor, Gaurav Tower-I, Malviya Nagar, Jaipur 302017.
Tel: 0141-6701 614, Fax: 0141-2545 596

AHMEDABAD

APM Shopping Mall, 4th Floor, Shyamal-Karnayati, 100 ft Road,
Satellite, Ahmedabad 380051.
Tel: 079-6606 0623, Fax: 079-6606 0700

BANGALORE

1st Floor, The KFCC Building No. 28, 1st Main, Crescent Road,
High Grounds, Bangalore 560011.
Tel: 080-6647 2000, Fax: 080-2237 4673

CHENNAI

1, Sidco Industrial Estate, Ambattur, Chennai 600098.
Tel: 044-6654 4444/4460, Fax: 044-6654 4445

VIJAYWADA

Survey No: 202/1D, 204/SD & 204/60, Enikepadu 521108,
Vijayawada Andhra Pradesh.
Tel: 040-66431000

KOLKATA

Salt Lake City, Sector V, Block GN, Plot No. 30, Kolkata 700091.
Tel: 033-6601 3829, Fax: 0033-2357 8271

RAIPUR

Plot No. 9/1, Mahoba Bazar, Raipur 492001 (C.G.).
Tel: 0771-6606 609

HYDERABAD

201 & 202, Lala-1, Landmark 5-4-94 to 97, 2nd Floor, M. G.
Road, Ranigunj, Secunderabad 500003, Telangana State.
Tel: 040-6643 1000, Fax: 040-6643 1039/1200